

QVESARUM

Mini Green House

Mini Green House Prefabricated Mahogany

Size L : 1500mm x W : 600mm X H : 1700mm

(Finish : Oiled)

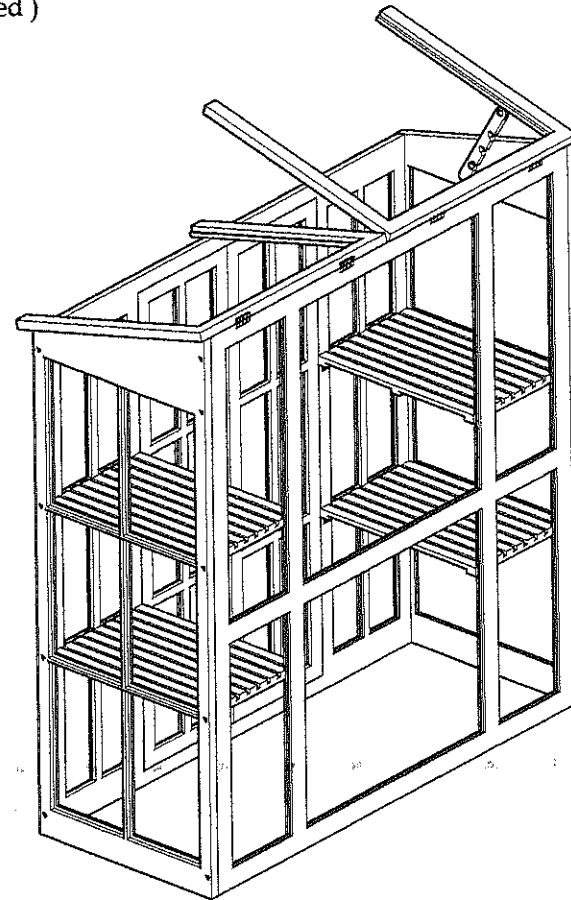
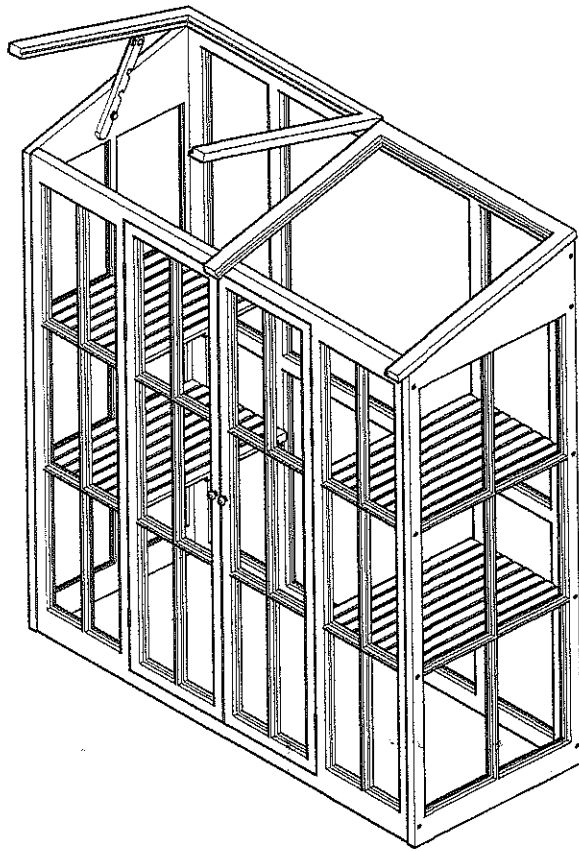

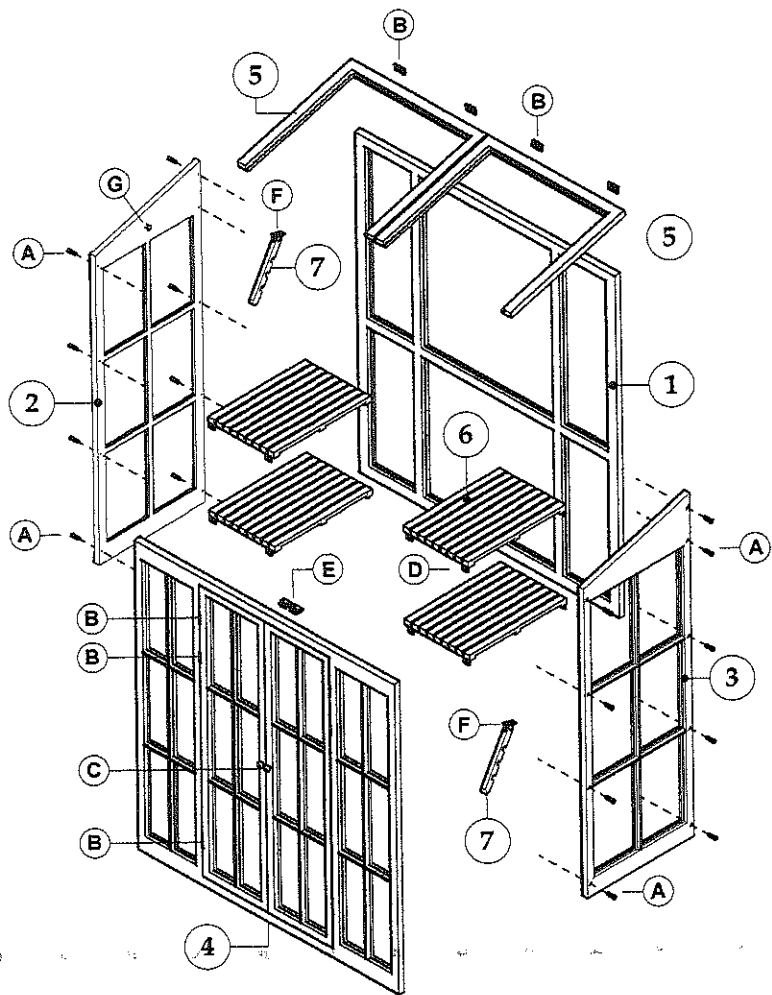

No	Component	Qty
1	Back View	1
2	Left Side View	1
3	Right Side View	1
4	Front View	1
5	Top Window	2
6	Shelves	4
7	Slide	2

No	Fixing	Qty
A	Bolt 6,0 x 40 mm	18
B	Hinges 2 Inch	10
C	Door Knob	2
D	Comer Brace	16
E	Magnet	2
F	Fitting on Slide	2
G	Fitting on Left and Right side	2

FIXING PACK

<p>A. 18</p> <p>Bolt 6,0x40mm (Knockdown)</p>	<p>D. 16</p> <p>Corner Brace</p>	<p>G. 2</p> <p>Fitting on left and Right sides</p>
<p>B. 10</p> <p>Hinges 2 inch</p>	<p>E. 2</p> <p>Magnet</p>	<p> 140</p> <p>Screw 3,0 x 20mm (For Code B, D, E and Code F)</p>
<p>C. 2</p> <p>Door Knob</p>	<p>F. 2</p> <p>Fitting on slide</p>	<p> 2</p> <p>Required Tools (For code A)</p>

QVESARUM

ASSEMBLY INSTRUCTIONS FOR MINI GREEN HOUSE

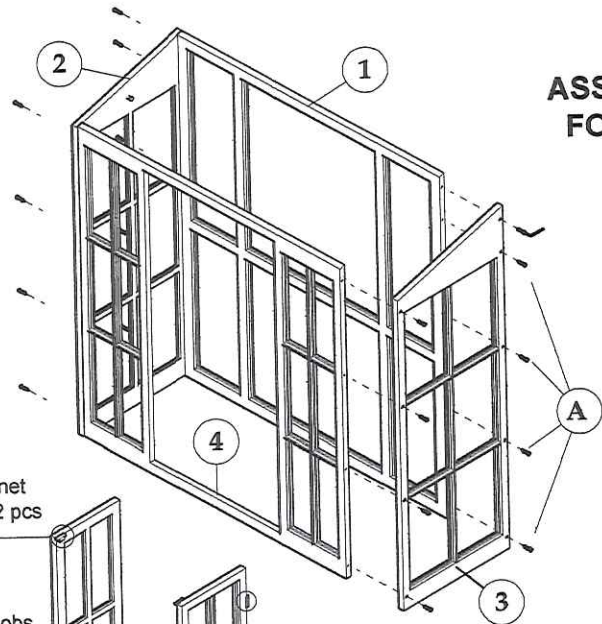

STEP 1
Fix the left and right hand side panels to the back panel as shown using bolt 6,0x40mm for each, screwing through the back panel frame work into the side panel.

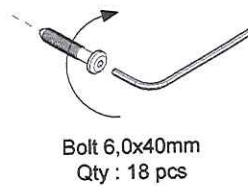

Bolt 6,0x40mm
Qty : 18 pcs

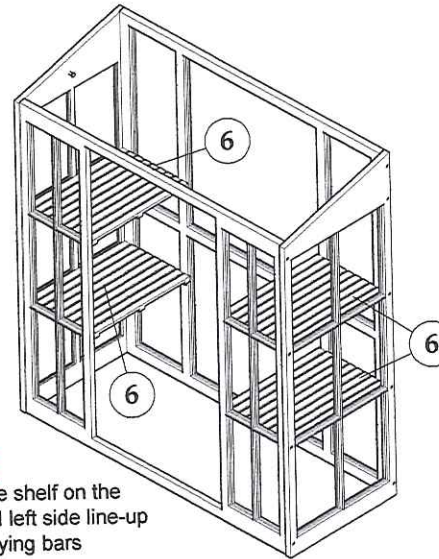

STEP 2
Place the shelf on the right and left side line-up to the laying bars

Screw 3,0x20mm
Qty : 64 pcs

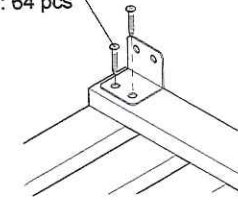

Corner Brace
Qty : 16 pcs

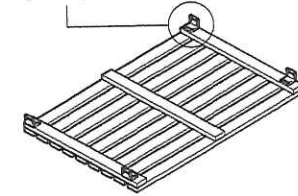

Place four of the corner brace on the underside of each shelf.

Magnet
Qty : 2 pcs

Door Knobs
Qty : 2 pcs

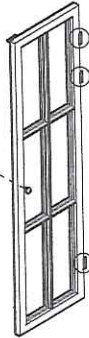

Three hinges to each of the doors, using 3x25mm screws for each hinge.

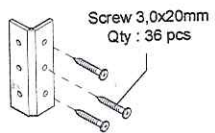

Hinges on doors
Qty : 6 pcs

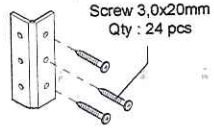

Hinges on Top window
Qty : 4 pcs

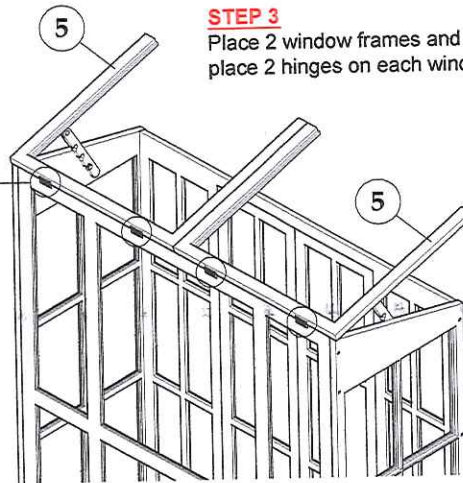

STEP 3
Place 2 window frames and place 2 hinges on each window

Place fittings on the underside of each window

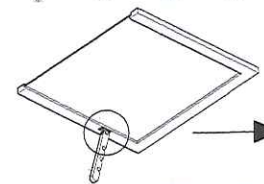
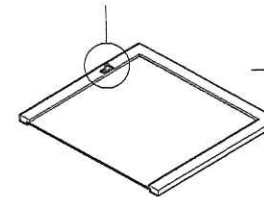

Screw 3,0x20mm
Qty : 8 pcs

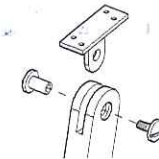
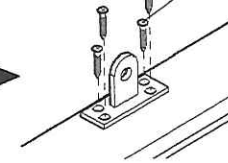

Install both fittings in the slide